

**UEBEX**  
LED LIGHTING

## MONTAGEANLEITUNG | USER MANUAL ALESSA2

ALA2031.XBC22 - L=1200mm

ALA2040.XBC22 - L=1500mm

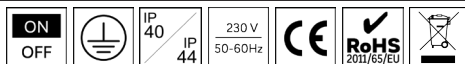
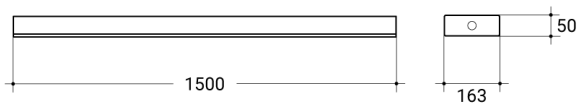
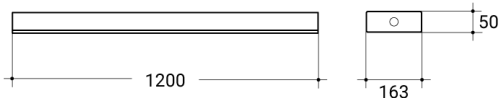

### INFORMATION ZUR EU ÖKODESIGN VERORDNUNG

INFORMATION ON THE EU ECODSIGN DIRECTIVE

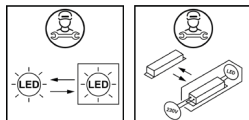

Wichtige Informationen zur Energieeffizienz von UEBEX Leuchten, sowie zur EU Ökodesignverordnung finden Sie unter [www.uebex.com](http://www.uebex.com)

Important information on the energy efficiency of UEBEX luminaires, as well on the EU Ecodesign Regulation can be found at [www.uebex.com](http://www.uebex.com)

Dieses Produkt enthält eine Lichtquelle der Energieeffizienzklasse C

This product contains a light source of energy efficiency class C

## INSTALLATIONSHINWEISE | INSTALLATION INSTRUCTION

### ACHTUNG | WARNING

1. **Versorgungsspannung vor der Installation ausschalten |**  
Switch the power off before installation.
2. **Erst nach vollständiger Installation und Prüfung des Stromkreises wieder einschalten |**  
Switch on only after complete installation and examination of the circuit.
3. **Installation und Wartung nur durch eine Elektrofachkraft |**  
Professional electrician for installation and maintenance only



Turn Off



## SICHERHEITSHINWEISE | SAFETY NOTES



Caution, risk of  
Electric shock.

1. Lesen Sie die Anweisungen und überprüfen Sie, ob alle Werkzeuge und Zubehörteile vorhanden sind, um die Installation korrekt durchzuführen. |

Read the instructions and check you have all tools and accessories to complete the installation correctly.

2. Die Installation darf nur durch einen lizenzierten Elektriker durchgeführt werden. |

Licensed electrician for installation only.

3. Vergewissern Sie sich immer, dass der Strom ausgeschaltet und die Leuchte abgekühlt ist, bevor Sie Wartungs-, Reinigungs- oder Einstellarbeiten an der Leuchte vornehmen. |

Always ensure the power is off and the luminaire has cooled down before performing any maintenance, cleaning or adjustment to the luminaire.

4. Installieren Sie keine Leuchten in der Nähe von Wärmequellen. |

Do not install any luminaire near heat sources.

5. Überschreiten Sie die zulässige Versorgungsnennspannung oder Stromstärke nicht. |

Do not exceed the nominal supply voltage or amperage rating.

6. Um Personenverletzungen oder Schäden an der Leuchte zu vermeiden, vergewissern Sie sich, dass die Stromkabel und Schrauben fest sitzen, bevor Sie die Stromversorgung anschließen. |

To avoid personal injury or damage to the luminaire, please ensure that the power leads and screws are secure before connecting the power.

7. Die in dieser Leuchte enthaltene Lichtquelle darf nur durch den Hersteller ersetzt werden. |

The light source contained in the luminaire shall only be replaced by the manufacturer.

# INSTALLATION

1

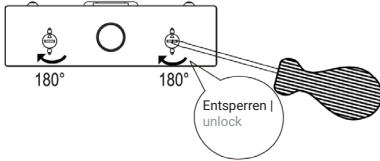
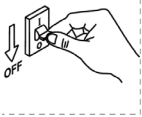

2

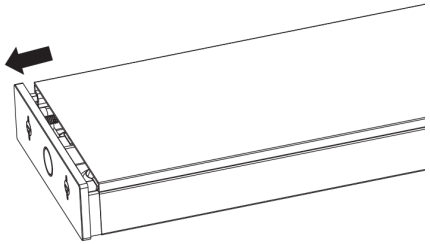

3

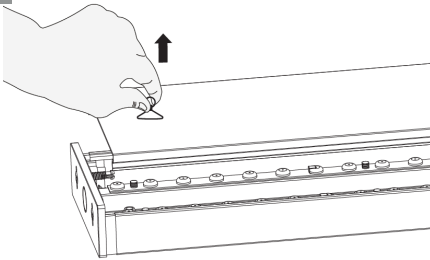

4

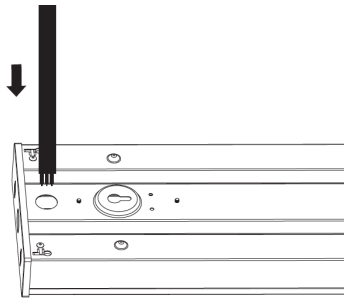

5

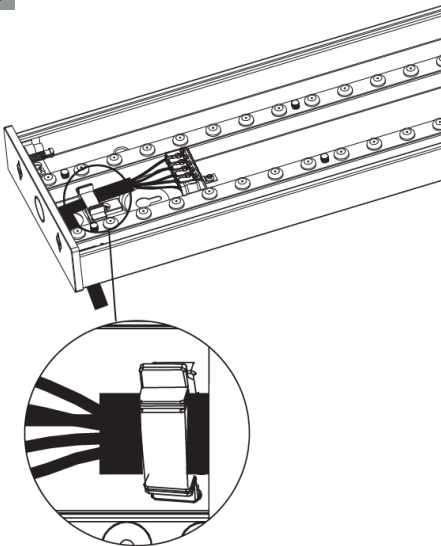

6

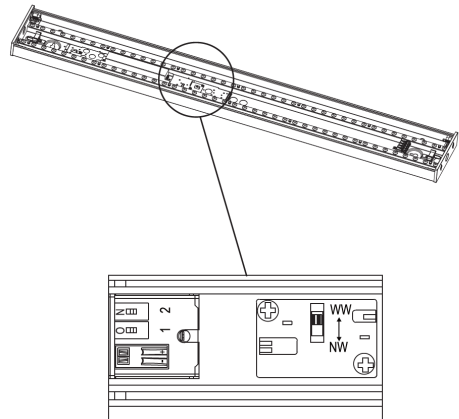

Einstellung der Leistung und Lichtfarbe |  
Power and light colour setting

# INSTALLATION

7

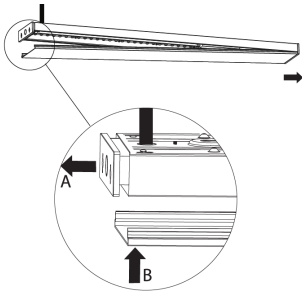

8

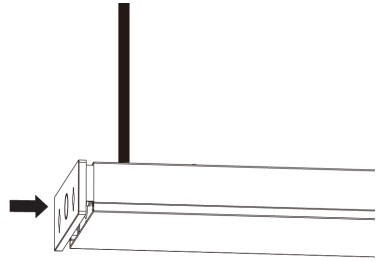

9

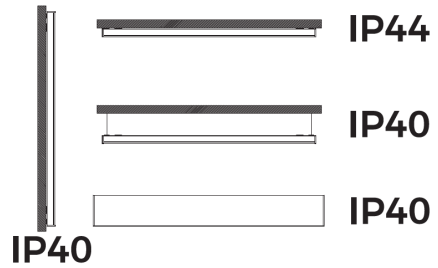
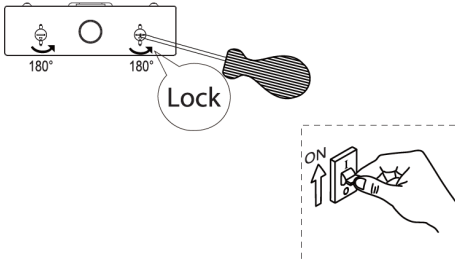

X 2st

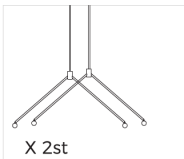
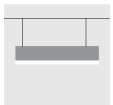

X 2st

